

From Heat to Electricity

with the Againity ORC turbine



Electricity production from
Biomass/biogas boilers – Waste incinerators –
Industrial waste heat – Gas engines/turbines



From heat to electricity

From heat to electricity

With Againty's innovative ORC turbine your heat production can easily be combined with electricity production.

Againty offers ORC turbines turning low-grade heat into electricity. Biomass boilers, bio-gas boilers, household waste and industrial waste heat are typical heat sources that can now be utilized for electricity production, thanks to an innovative turbine solution which minimizes pay-back times.

The ORC technology

Againty's system is based on the long-known ORC technology (Organic Rankine Cycle),

illustrated in the image below. The technology includes a steam turbine set in motion by the pressure of a vaporized internal working medium. The rotating turbine then drives a generator that produces electricity. In good conditions the electrical efficiency is up to 20%.

Heating and cooling source

To heat up the internal working medium a heat source with a temperature over 90°C is connected to the evaporator. After the turbine the working medium is cooled down in the condenser connected to either a district heating network, air cooling system or other cooling water.

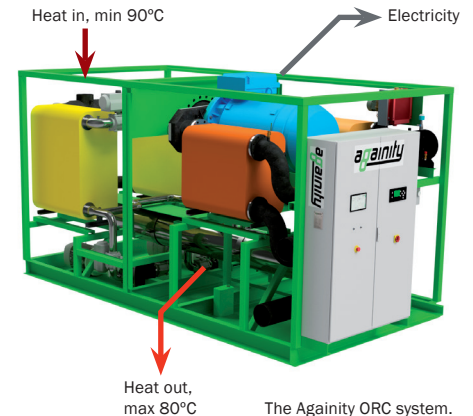

The Againty ORC system.
Model AT200.

Simple installation

1. Two pipes connected to boiler circuit.
2. Two pipes connected to district heating network circuit.
3. Connection of electricity.
4. You have a CHP plant!

Flow chart of the Againty ORC system

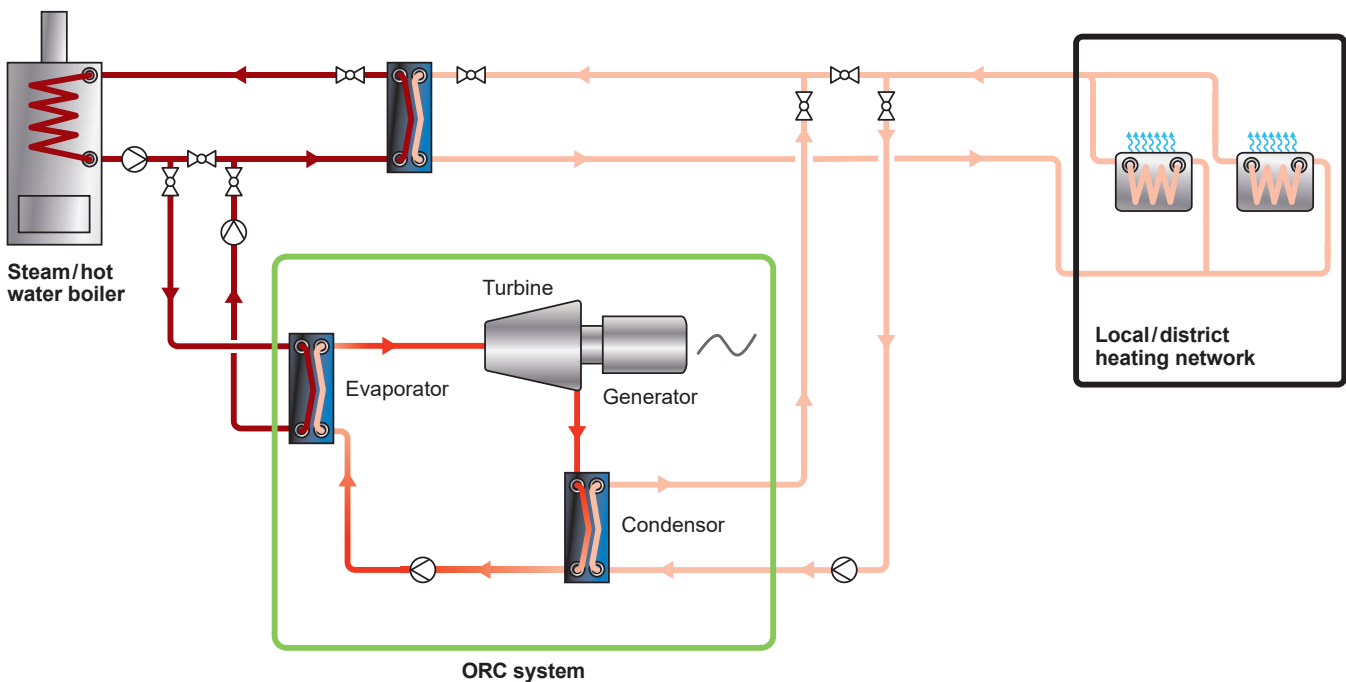

Locally produced – Cost effective – Fossil free – Weather independent

Typical applications

Againity is active in a wide range of industries since the ORC turbines can utilize heat from any liquid or gas as long as it exceeds 90°C. Examples of heat sources from our main segments are presented below.

Biomass boilers



Incineration plants fueled by i.e. wood chips or biogas.

Household waste



Small-scale incineration and energy recovery from waste.

Industrial waste heat



Factories producing aluminum, chemicals, bricks, beverages, etc.

Power plants



Waste heat from i.e. gas turbines, diesel engines, or heat from solar collectors.

Quality first

Thanks to the unique design of our patented turbine and the low number of moving parts in the system, a high-quality product can be offered. This minimizes the need for service and maintenance and significantly shortens the payback time.

Benefits with Againity's ORC solution

Comprehensive customer offering

- The solution is tailored according to customer needs.
- The offer can include ancillary components such as boilers, cooling equipment, piping, etc.
- The turbine is suitable for various different application thanks to the large temperature and power range that can be handled.

Convenient transportation and installation

- Transport in standard containers or on frame.
- Easy installation with connecting the hot water, cooling water and electricity.
- Short installation time – from 1 week.

Low investment and operating costs

- OPEX from 0.002 USD/kWh.
- Standardized and modular systems allows a low investment cost.

High availability







- Robust system with few moving parts.
- > 97% availability.
- Service from 1 day/year.

From heat to electricity with the Againity ORC turbine

Since 2013 Againity has developed and installed ORC turbines for heating plants. Get in touch with us today for a free analysis of the potential for electricity production at your heating plant.



The Againity ORC systems are built from 50 kW electricity production and can be installed in parallel for higher electrical output. The ORC system is delivered pre-assembled and ready for connection to hot water and cooling water. Againity can also include additional equipment such as boilers, cooling fans and other equipment as needed.

	AT50	AT100	AT200	AT500	AT1000	AT2500
						
Installed capacity	50 kW	100 kW	200 kW	500 kW	1000 kW	2500 kW
Size ¹ (LxWxH)	3.5 x 1.6 x 2.1 m	3.8 x 1.5 x 2.4 m	5.2 x 2.3 x 2.4 m	6.0 x 2.3 x 2.5 m	12.2 x 2.5 x 2.9 m	20.0 x 2.5 x 2.9 m
					Size of 40 ft container	Size of 40 + 20 ft containers
Voltage ² Freq.	50-60 Hz	50-60 Hz	50-60 Hz	50-60 Hz	50-60 Hz	50-60 Hz
	380-415V	380-415V	380-415V	380-415V	3000-6000V	3000-6000V

¹ The measurements are approximate and tailored according to technical conditions of each built ORC system.

² Other voltages on request.

Copyright © Againity

Againity AB

Laxholmstorget 3 (3rd fl),
SE-602 21 Norrköping, Sweden
Phone: +46 (0)70 529 32 23,
e-mail: info@againity.com
www.againity.com

